



Acorn Computers Limited, 4a Market Hill, Cambridge CB2 3NJ, England. Telephone 0223 312772

ACORN TECHNICAL MANUAL

Extension Memory Board .. 200,003

Introduction	..	Page 1
Parts List	..	Page 2
Circuit Diagram	Page 3
Board Layout	Page 5
Address Selection	..	Page 6

Issue 3 March 1980©

INTRODUCTION

The Acorn Extension Memory board provides an extra 8K bytes of user RAM space and has sockets for two R.O.M.'s which may be 2, 4 or 8K devices providing 4 or 8K bytes of firm ware. The board connects to the Acorn computer bus via a 32 way Euro-connector and bus buffers ensure a low loading on the bus. A full set of integrated circuit sockets are supplied with each board even if the full memory option is not purchased.

The board operates from a single 5v supply on the Acorn bus and consumes not more than 1.6 amperes when a full compliment of 2114's is fitted.

A write protect switch may be fitted by breaking a track and fitting a single pole, single throw switch across the break, wiring to the two holes provided. Refer to P.C.B. layout on page 5.

The RAM and ROM may each set to appear in any 2 out of 16 blocks in the address map by fitting wire links, see page 6. If the board is to be used either without any ROM or without any RAM then both the RAM and ROM address links should be fitted in the same positions ensuring that one input to IC 20 pins 9 or 10 is not left open circuit.

In systems with a Valid Memory Address signal on the backplane a 64 way Euro-connector may be fitted and the VMA link on the P.C.B. may be cut allowing the signal to be fed to the board.

PARTS LIST FOR ACORN MEMORY BOARD

P.C.B.	Acorn Computers Ltd Pt. No. 200,003	
IC 1-16	2114 Random Access Memory	and 18 pin sockets
IC 17-18	ROM or EPROM of 2516 or 2532 style & 24 pin sockets	
	or	
IC 17 only	ROM or EPROM of 2564 style	and 24 pin socket
IC 19	74LS42 Decoder	and 16 pin socket
IC 20	74LS00 NAND gate	and 14 pin socket
IC 21, 23	81LS95 or 97 Bus buffer	and 20 pin sockets
IC 22	INS 8208 Bus Buffer	and 20 pin socket
IC 24	74LS42 Decoder from National Semiconductor	
		and 16 pin socket
IC 25	74LS00 NAND gate	and 14 pin socket
CI-7	47 nF or 100 nF Capacitor	
C 8	10, 15 or 47 uF Electrolytic Capacitor	
RI	1K Resistor	

nb. INS 8208 is equivalent to DP8304

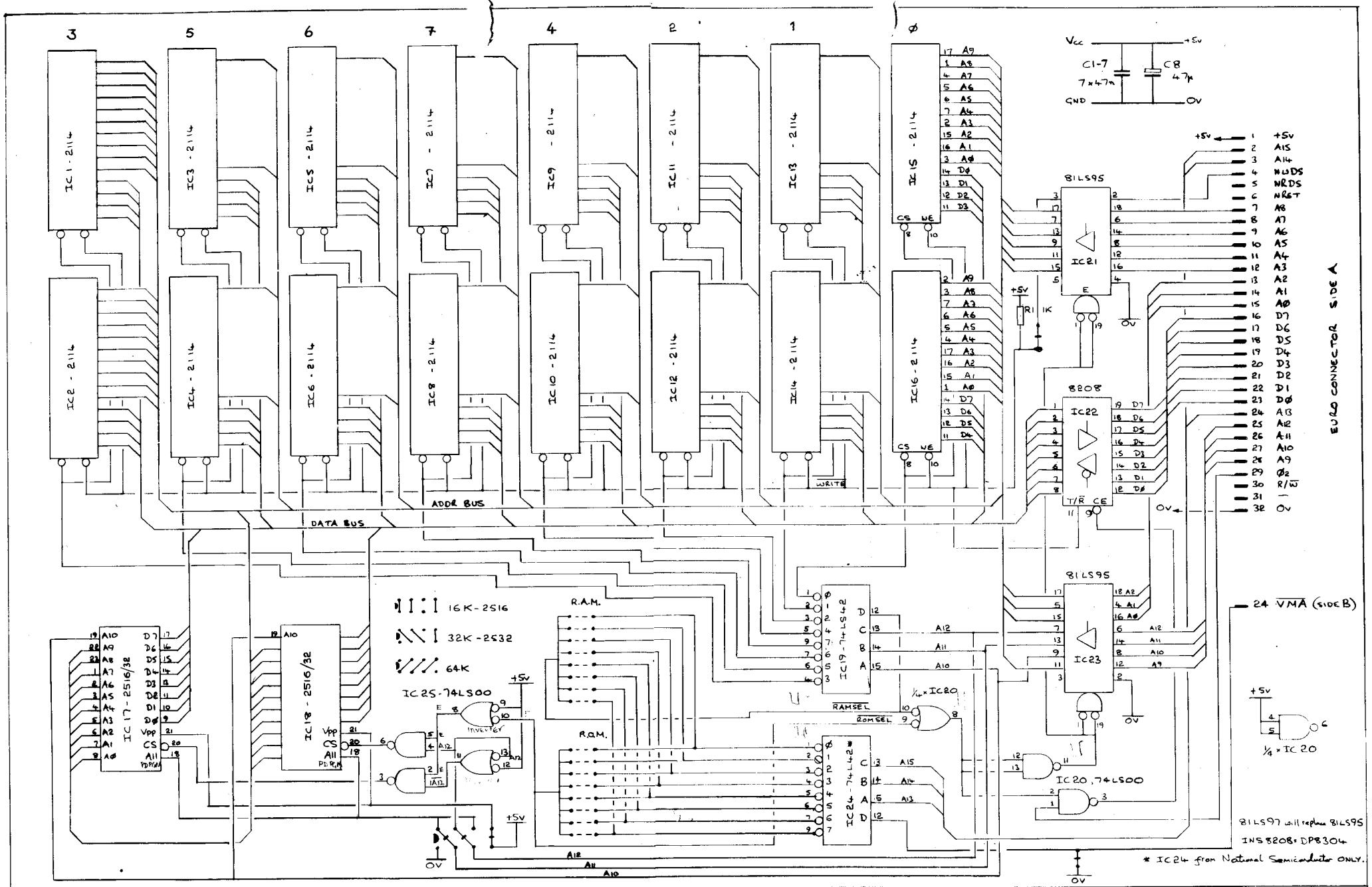

ISSUE	1	2	2	3
DATE	21-05-79	16-11-79	19-12-79	13-2-80
		CBT	CBT	CBT

© COPYRIGHT 1979
 ACORN COMPUTERS LTD
 4A, MARKET HILL
 CAMBRIDGE
 0223-312772

CBT
 21-05-79
 8K RAM + 8K PROM
 P.C.B. CIRCUIT DIAGRAM

200.003/C
 ACORN COMPUTERS LTD.

PCB LAYOUT.

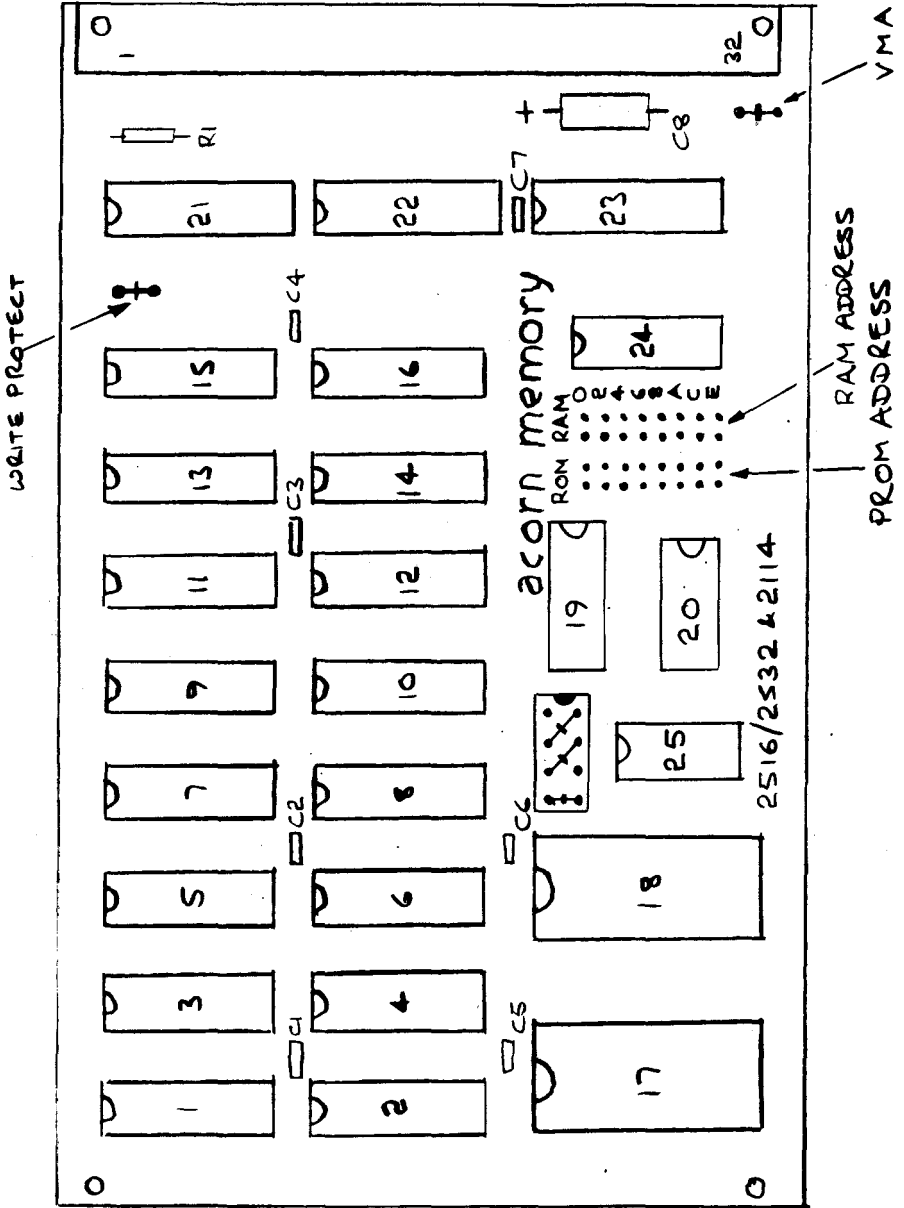

ADDRESS SELECTION

Wire links must be fitted to the board to determine where the ROM and RAM exist in the address map. The RAM map for one board is shown:

IC 7 & 8	1FFF
IC 5 & 6	1BFF
IC 3 & 4	17FF
IC 9 & 10	12FF
IC 1 & 2	0FFF
IC 11 & 12	0BFF
IC 13 & 14	07FF
IC 15 & 16	02FF
	0000

This may be positioned to start at 0000, 2000, 4000 etc by linking in position 0, 2, 4 etc on the board.

Three ROM maps are possible.

IC 18	1FFF
IC 17	
IC 18	
IC 17	0000

Using 2516's or 2716's which appear twice in the 8K byte space. Wire links as shown:—

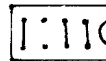

IC 18	1FFF
IC 17	
	0000

Using 2532's. This is the standard configuration for the board and these links are tracked on the P.C. B. and must be cut if one of the other schemes is required:—

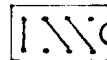

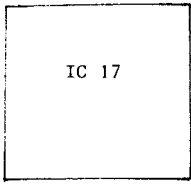

FFFF

Using one 2564 only. Wire links as shown:-

0000

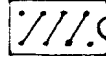

Again links in 0, 2, 4 etc will set the start address of the ROM space to be 0000, 2000, 4000 etc.

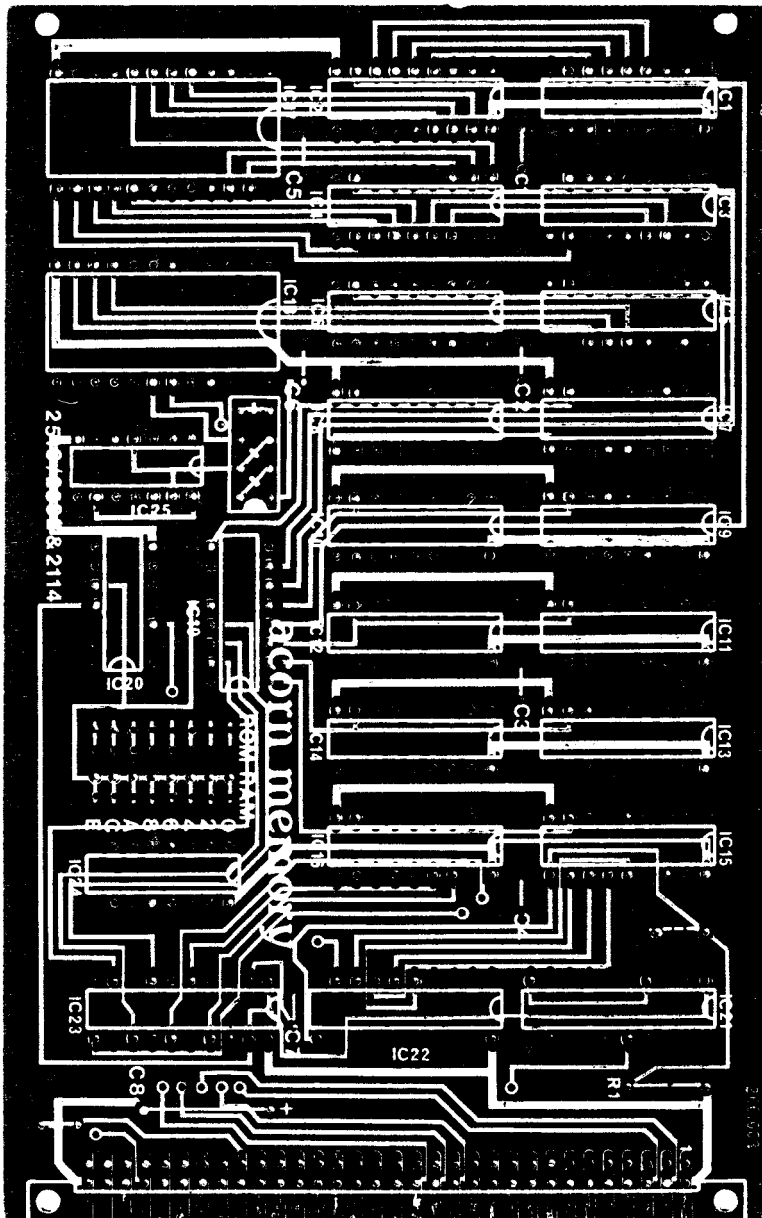

Acorn Memory Board (component side)

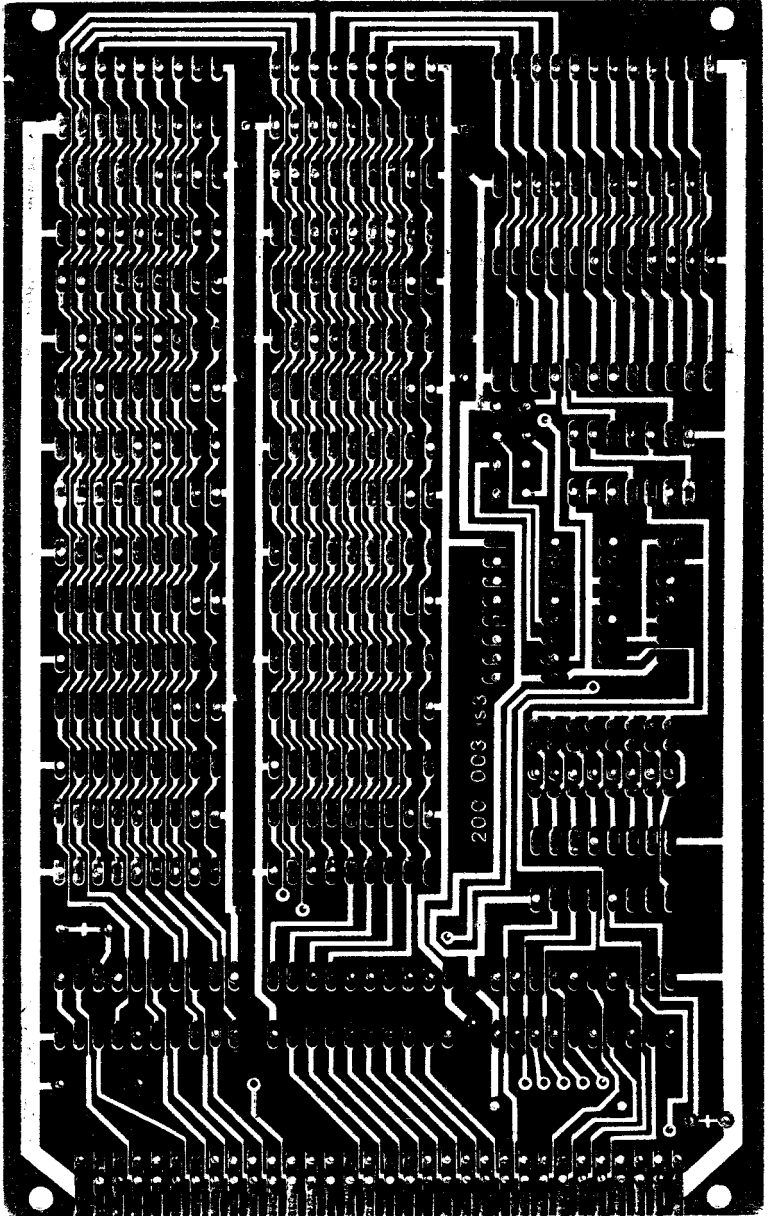

Acorn memory board (reverse side)