

## 2048-word x 8-bit High Speed CMOS Static RAM

### FEATURES

- Single 5V Supply
- High speed: Fast Access Time                      120ns/150ns/200ns (max.)
- Low Power Standby and Low Power Operation
  - Standby:                      100μW (typ.)
  - 10μW (typ.) (L-version)
  - Operation:                    200mW (typ.)
  - 175mW (typ.) (L-version)
- Completely Static RAM:    No clock or Timing Strobe Required
- Directly TTL Compatible: All Input and Output
- Pin Out Compatible with Standard 16K EPROM/MASK ROM
- Equal Access and Cycle Time
- Capability of Battery Back Up Operation (L-version)

### ORDERING INFORMATION

Type No.	Access Time	Package
HM6116P-2	120ns	600mil 24pin Plastic DIP
HM6116P-3	150ns	
HM6116P-4	200ns	
HM6116LP-2	120 ns	
HM6116LP-3	150 ns	24pin Plastic SOP
HM6116LP-4	200 ns	
HM6116FP-2	120 ns	
HM6116FP-3	150 ns	
HM6114FP-4	200 ns	
HM6116LFP-2	120 ns	
HM6116LFP-3	150 ns	
HM6116LFP-4	200 ns	

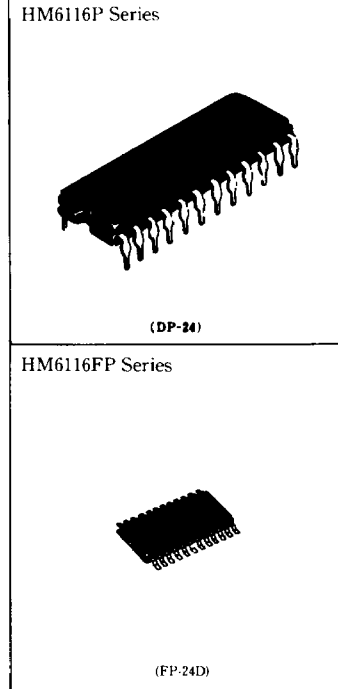

### FUNCTIONAL BLOCK DIAGRAM

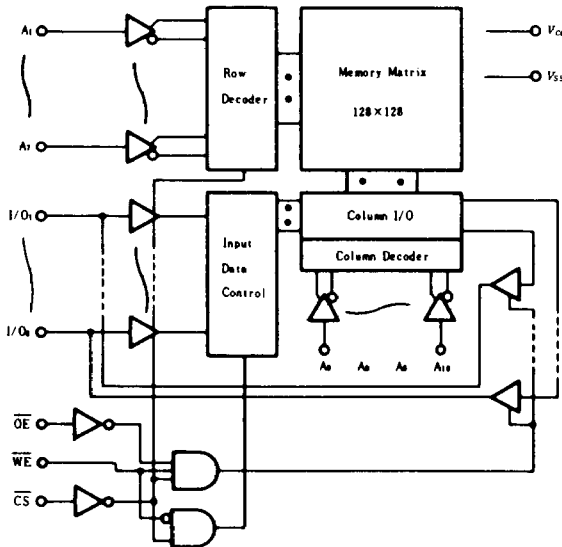

### PIN ARRANGEMENT

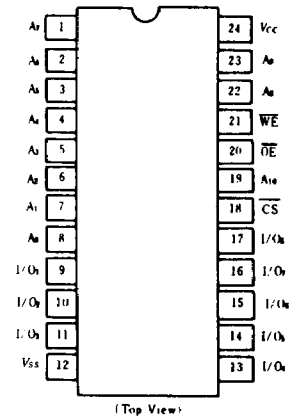

Note) This device is not available for new application.

### ■ ABSOLUTE MAXIMUM RATINGS

Item	Symbol	Rating	Unit
Voltage on Any Pin Relative to $V_{SS}$	$V_T$	-0.5*1 to +7.0	V
Operating Temperature	$T_{op}$	0 to +70	°C
Storage Temperature	$T_{stg}$	-55 to +125	°C
Storage Temperature Under Bias	$T_{mb}$	-10 to +85	°C
Power Dissipation	$P_T$	1.0	W

Note) \*1. -3.5V for pulse width  $\leq 50$ ns

### ■ TRUTH TABLE

$\overline{CS}$	$\overline{OE}$	WE	Mode	$V_{CC}$ Current	I/O Pin	Ref. Cycle
H	x	x	Not Selected	$I_{SB}, I_{SB1}$	High Z	
L	L	H	Read	$I_{CC}$	Dout	Read Cycle (1)~(3)
L	H	L	Write	$I_{CC}$	Din	Write Cycle (1)
L	L	L	Write	$I_{CC}$	Din	Write Cycle (2)

### ■ RECOMMENDED DC OPERATING CONDITIONS ( $T_a=0$ to +70°C)

Item	Symbol	min	typ	max	Unit
Supply Voltage	$V_{CC}$	4.5	5.0	5.5	V
	$V_{SS}$	0	0	0	V
Input Voltage	$V_{IH}$	2.2	3.5	6.0	V
	$V_{IL}$	-0.3*1	—	0.8	V

Note) \*1. -3.0V for pulse width  $\leq 50$ ns.

### ■ DC AND OPERATING CHARACTERISTICS ( $V_{CC}=5V \pm 10\%$ , $V_{SS}=0V$ , $T_a=0$ to +70°C)

Item	Symbol	Test Conditions	HM6116-2			HM6116-3/4			Unit
			min	typ*1	max	min	typ*1	max	
Input Leakage Current	$ I_{LI} $	$V_{CC}=5.5V$ , $V_{IN}=V_{SS}$ to $V_{CC}$	—	—	10	—	—	10	$\mu A$
			—	—	2*3	—	—	2*3	
Output Leakage Current	$ I_{LO} $	$\overline{CS}=V_{IH}$ or $\overline{OE}=V_{IH}$ , $V_{I/O}=V_{SS}$ to $V_{CC}$	—	—	10	—	—	10	$\mu A$
			—	—	2*3	—	—	2*3	
Operating Power Supply Current	$I_{CC}$	$\overline{CS}=V_{IL}$ , $I_{I/O}=0mA$	—	40	80	—	35	70	mA
			—	35*3	70*3	—	30*3	60*3	
Average Operating Current	$I_{CC2}$	Min. cycle, duty=100% $I_{I/O}=0mA$	—	40	80	—	35	70	mA
			—	35*3	70*3	—	30*3	60*3	
Standby Power Supply Current	$I_{SB}$	$\overline{CS}=V_{IH}$	—	5	15	—	5	15	mA
			—	4*3	12*3	—	4*3	12*3	
Output Voltage	$V_{OL}$	$\overline{CS} \geq V_{CC} - 0.2V$ , $0V \leq V_{IN} \leq 0.2V$ or $V_{CC} - 0.2V \leq V_{IN}$	—	0.02	2	—	0.02	2	$\mu A$
			—	2*3	50*3	—	2*3	50*3	
Output Voltage	$V_{OH}$	$I_{OL}=4mA$	—	—	0.4	—	—	—	V
			—	—	—	—	—	0.4	V
			—	—	—	—	—	—	V
Output Voltage	$V_{OH}$	$I_{OH}=-1.0mA$	2.4	—	—	2.4	—	—	V

Notes) \*1.  $V_{CC}=5V$ ,  $T_a=25^\circ C$

\*2. Reference Only

\*3. This characteristics are guaranteed only for L-version.



■ CAPACITANCE ( $f=1\text{MHz}$ ,  $T_a=25^\circ\text{C}$ )

Item	Symbol	Test Conditions	typ	max	Unit
Input Capacitance	$C_{in}$	$V_{in}=0\text{V}$	3	5	pF
Input/Output Capacitance	$C_{LO}$	$V_{LO}=0\text{V}$	5	7	pF

Note) This parameter is sampled and not 100% tested.

■ AC CHARACTERISTICS ( $V_{CC}=5\text{V}\pm 10\%$ ,  $T_a=0$  to  $+70^\circ\text{C}$ )

● AC TEST CONDITIONS

- Input Pulse Levels: 0.8 to 2.4V
- Input Rise and Fall Times: 10 ns
- Input and Output Timing Reference Levels: 1.5V
- Output Load: 1TTL Gate and  $C_L$  (100pF) (including scope and jig)

● READ CYCLE

Item	Symbol	HM6116-2		HM6116-3		HM6116-4		Unit
		min	max	min	max	min	max	
Read Cycle Time	$t_{RC}$	120	—	150	—	200	—	ns
Address Access Time	$t_{AA}$	—	120	—	150	—	200	ns
Chip Select Access Time	$t_{ACS}$	—	120	—	150	—	200	ns
Chip Selection to Output in Low Z	$t_{CLZ}$	10	—	15	—	15	—	ns
Output Enable to Output Valid	$t_{OE}$	—	80	—	100	—	120	ns
Output Enable to Output in Low Z	$t_{OLZ}$	10	—	15	—	15	—	ns
Chip Deselection to Output in High Z	$t_{CNZ}$	0	40	0	50	0	60	ns
Chip Disable to Output in High Z	$t_{ONZ}$	0	40	0	50	0	60	ns
Output Hold from Address Change	$t_{OH}$	10	—	15	—	15	—	ns

● WRITE CYCLE

Item	Symbol	HM6116-2		HM6116-3		HM6116-4		Unit
		min	max	min	max	min	max	
Write Cycle Time	$t_{WC}$	120	—	150	—	200	—	ns
Chip Selection to End of Write	$t_{CW}$	70	—	90	—	120	—	ns
Address Valid to End of Write	$t_{AW}$	105	—	120	—	140	—	ns
Address Set Up Time	$t_{AS}$	20	—	20	—	20	—	ns
Write Pulse Width	$t_{WP}$	70	—	90	—	120	—	ns
Write Recovery Time	$t_{WR}$	5	—	10	—	10	—	ns
Output Disable to Output in High Z	$t_{ONZ}$	0	40	0	50	0	60	ns
Write to Output in High Z	$t_{WNZ}$	0	50	0	60	0	60	ns
Data to Write Time Overlap	$t_{OW}$	35	—	40	—	60	—	ns
Data Hold from Write Time	$t_{DH}$	5	—	10	—	10	—	ns
Output Active from End of Write	$t_{OW}$	5	—	10	—	10	—	ns

■ TIMING WAVEFORM

● READ CYCLE (1) <sup>(1)</sup>

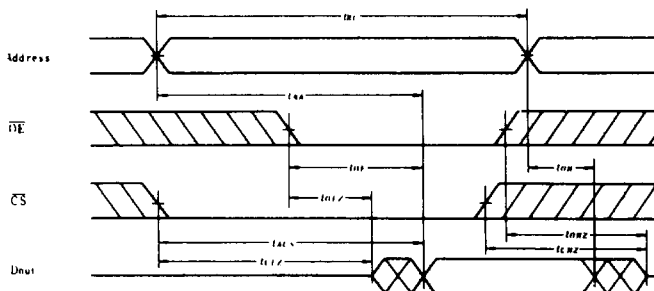

● READ CYCLE (2)<sup>(1)(2)(4)</sup>

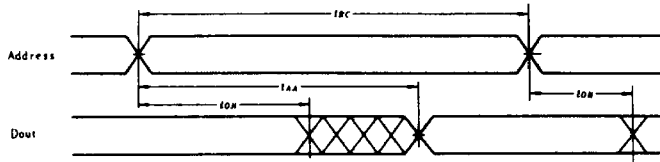

● READ CYCLE (3)<sup>(1)(2)(4)</sup>

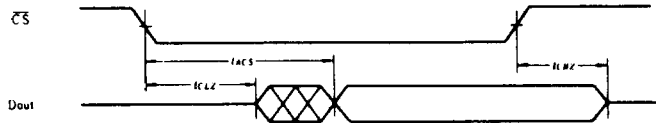

- NOTES:
1. WE is High for Read Cycle.
  2. Device is continuously selected,  $\overline{CS} = V_{IL}$ .
  3. Address Valid prior to or coincident with CS transition Low.
  4.  $\overline{OE} = V_{IL}$ .

● WRITE CYCLE (1)

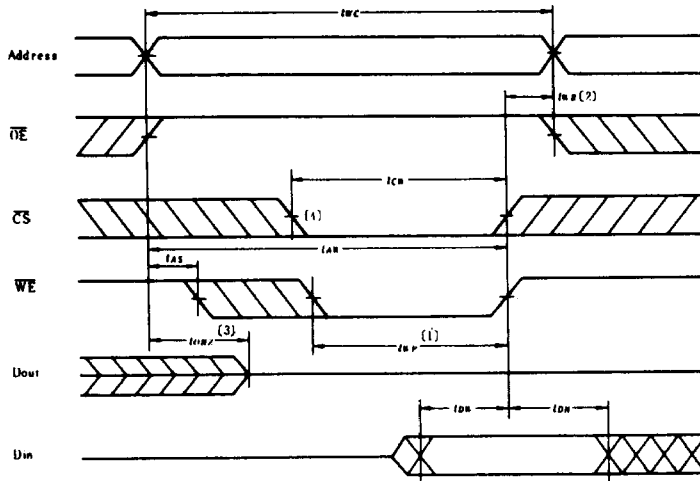

● WRITE CYCLE (2)<sup>(3)</sup>

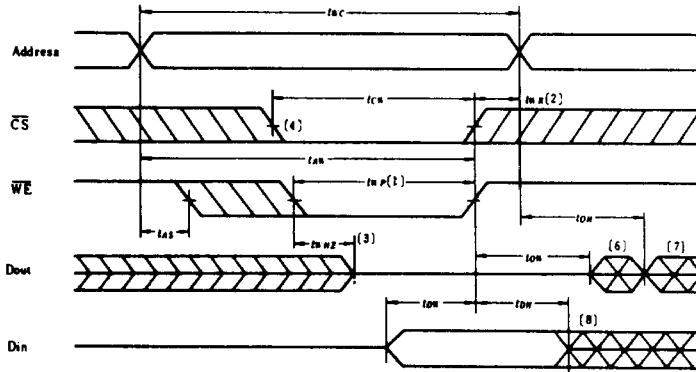

- NOTES:
1. A write occurs during the overlap ( $t_{WP}$ ) of a low  $\overline{CS}$  and a low  $\overline{WE}$ .
  2.  $t_{WR}$  is measured from the earlier of  $\overline{CS}$  or  $\overline{WE}$  going high to the end of write cycle.
  3. During this period, I/O pins are in the output state so that the input signals of opposite phase to the outputs must not be applied.
  4. If the  $\overline{CS}$  low transition occurs simultaneously with the  $\overline{WE}$  low transitions or after the  $\overline{WE}$  transition, output remain in a high impedance state.
  5.  $\overline{OE}$  is continuously low. ( $\overline{OE} = V_{IL}$ )
  6.  $D_{out}$  is the same phase of write data of this write cycle.
  7.  $D_{out}$  is the read data of next address.
  8. If  $\overline{CS}$  is Low during this period, I/O pins are in the output state. Then the data input signals of opposite phase to the outputs must not be applied to them.

■ LOW  $V_{CC}$  DATA RETENTION CHARACTERISTICS ( $T_a=0$  to  $+70^\circ\text{C}$ )

This characteristics are guaranteed only for L-version.

Item	Symbol	Test Conditions	min	typ	max	Unit
$V_{CC}$ for Data Retention	$V_{DR}$	$\overline{CS} \geq V_{CC} - 0.2V$ , $V_{in} \geq V_{CC} - 0.2V$ or $V_{in} \leq 0.2V$	2.0	—	—	V
Data Retention Current	$I_{CCDR}^{*1}$	$V_{CC}=3.0V, \overline{CS} \geq 2.8V, V_{IH} \geq 2.8V$ or $0V \leq V_{IN} \leq 0.2V$	—	—	30	$\mu\text{A}$
Chip Deselect to Data Retention Time	$t_{CDR}$	See Retention Waveform	0	—	—	ns
Operation Recovery Time	$t_R$		$t_{RC}^{*2}$	—	—	ns

Notes) \*1.  $10\mu\text{A}$  max at  $T_a=0^\circ\text{C}$  to  $+40^\circ\text{C}$ ,  $V_{IL}$  min =  $-0.3V$   
 \*2.  $t_{RC}$  = Read Cycle Time.

● Low  $V_{CC}$  Data Retention Waveform

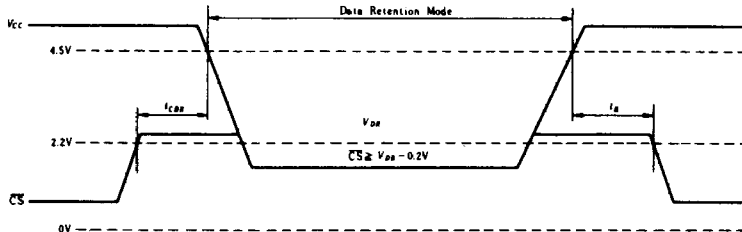

This datasheet has been downloaded from:

[www.DatasheetCatalog.com](http://www.DatasheetCatalog.com)

Datasheets for electronic components.